

living  
**b.p.c.**  
 bonprix collection

939970

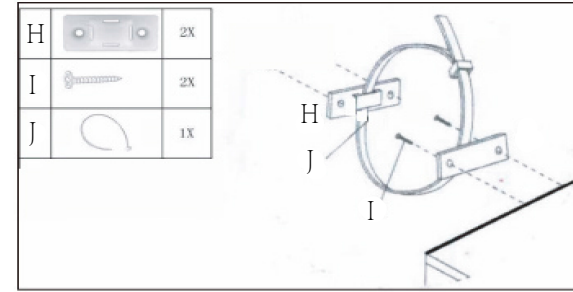
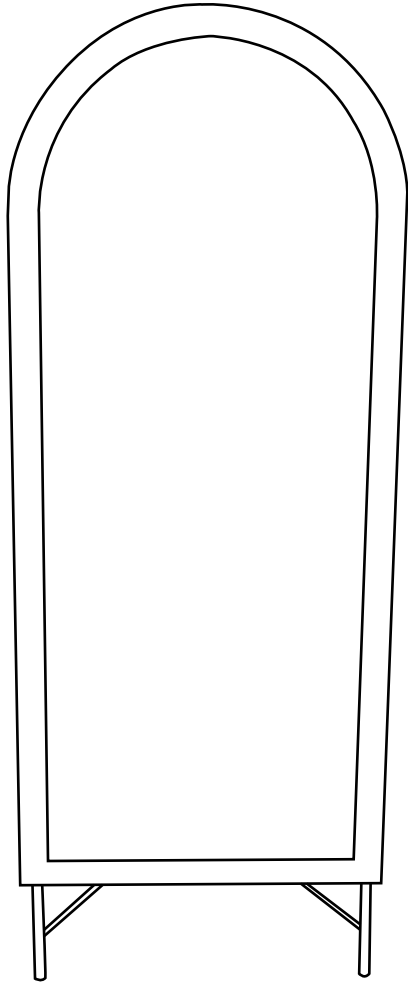

**FSC**

www.fsc.org

**100%**

Wood from well-managed forests

**FSC® C153871**

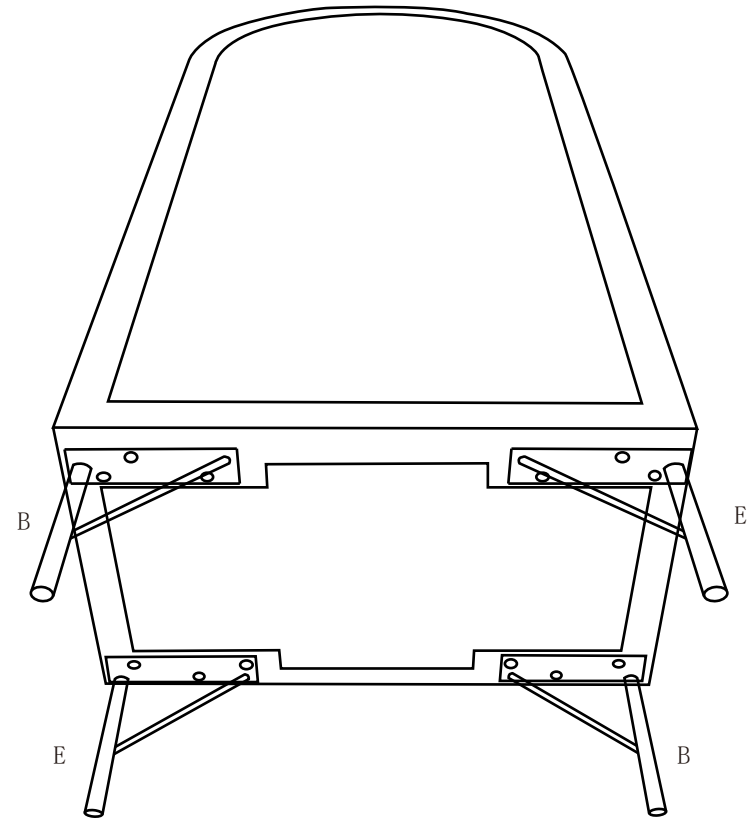

E	X	2
A	X	1
B	X	2

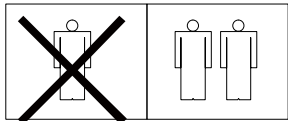

A

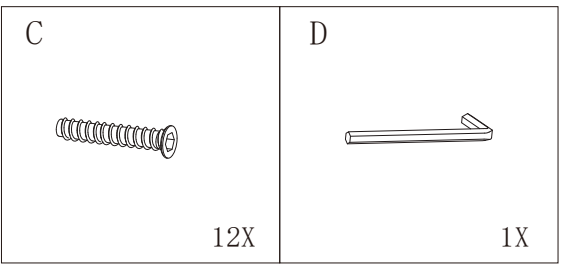

1

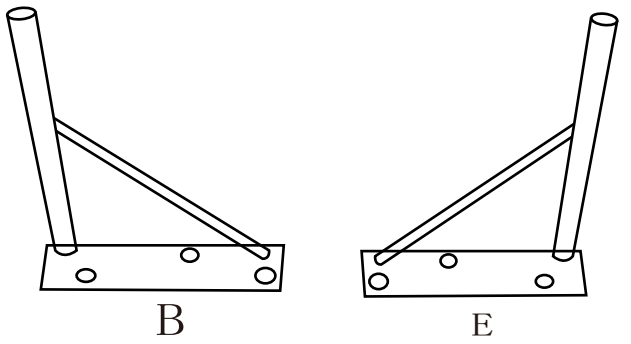

2

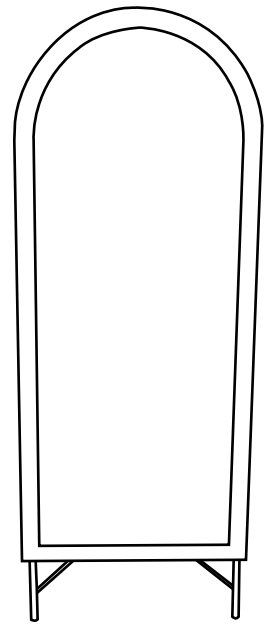

3

