

LKZ 640062

VARIANT 1

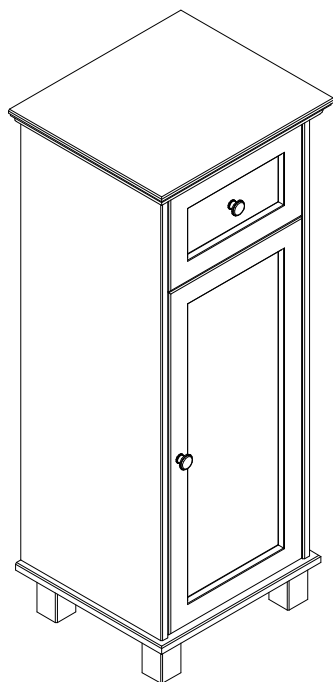

VARIANT 2

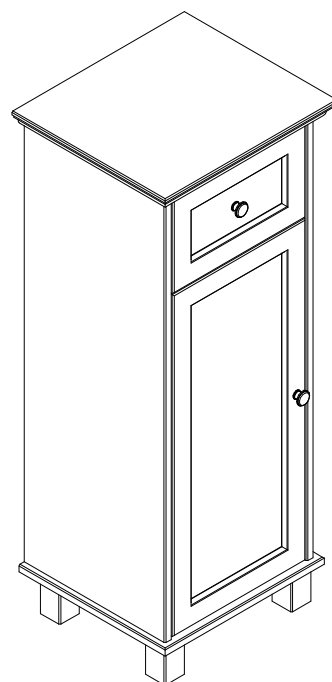

- | | | | |
|-----------|------------------------------------|-----------|--------------------------------|
| D | Montageanleitung | GB | Assembly instructions |
| FR | Notice de montage | IT | Istruzioni di montaggio |
| NL | Handleiding voor de montage | PL | Instrukcja montażu |
| CZ | Montážní návod | SK | Návod na montáž |
| HU | Szerelési útmutató | RO | Instrukțiuni de montaj |
| TR | Montaj talimatı | RU | Инструкция по монтажу |

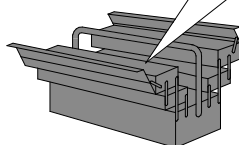
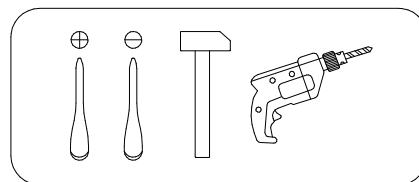
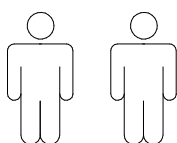

0
10
20
30
40
50
60
70
80
90
100
110
120
130
140
150
160
170
180
190
200









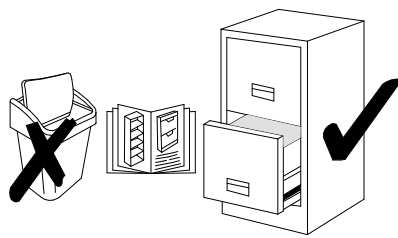
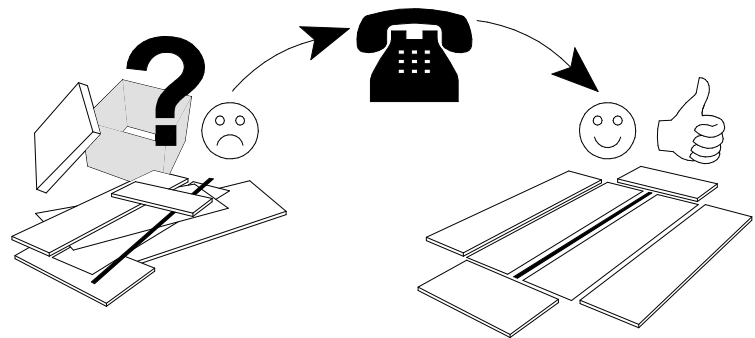

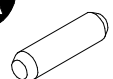

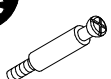

Service · Dienstverlening · Serwis · Servis · Сервисная служба

Name · Naam · Nazwa · Isim · Название

Nr. · No. · Номер

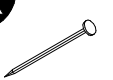
Тип · Type · Tip · Тип

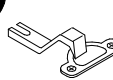
- A**  8x30
x12
- B**  15x9.5
x10
- C**  7x24
x10
- D**  x2
- E**  M4x22
x1
- F**  x4
- G**  x4
- H**  x1
- I**  x1
- J**  4.0x40
x4
- K**  x25
- L**  3.5x15
x4
- M**  x2
- N**  x2
- O**  3.5x35
x4
- P**  x2
- Q**  5.8x11
x4
- R**  M4x10
x3

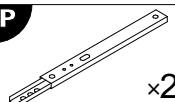
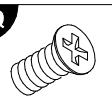
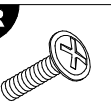
N	Size/MaB (mm)	Qty	✓	N	Size/MaB (mm)	Qty	✓
1	340x300	1		7	250x94	1	
2	312x286	1		8	229x94	1	
3	746x276	1		9	247x238	1	
4	746x276	1		10	764x282	1	
5	263x253	1		11	60x40	4	
6	250x94	1		12	580x260	1	
				13	260x160	1	



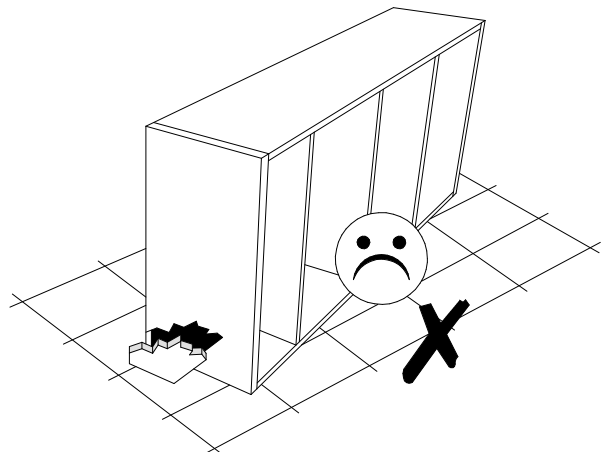
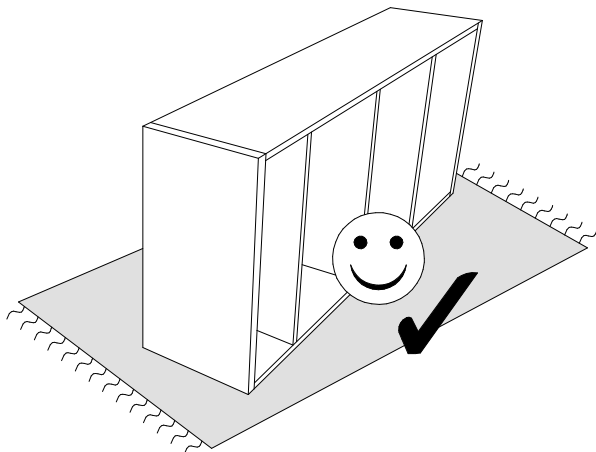
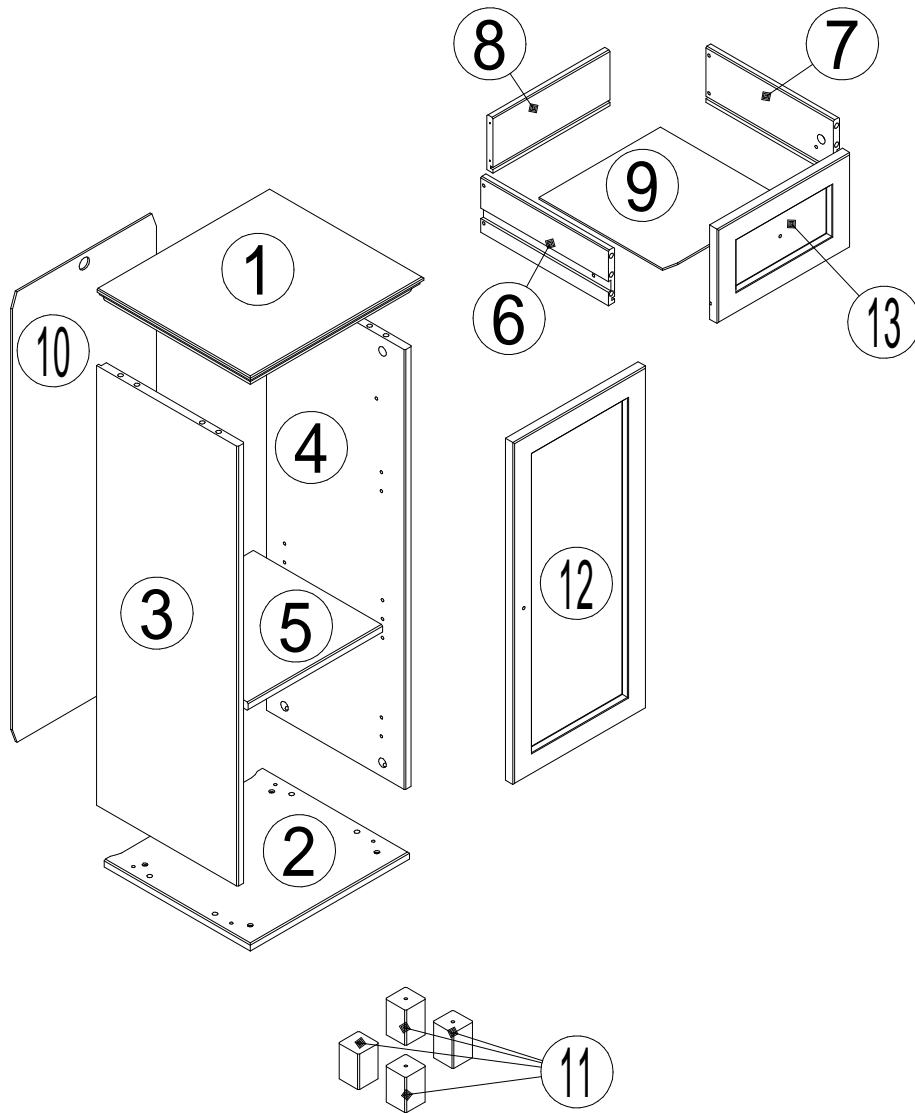

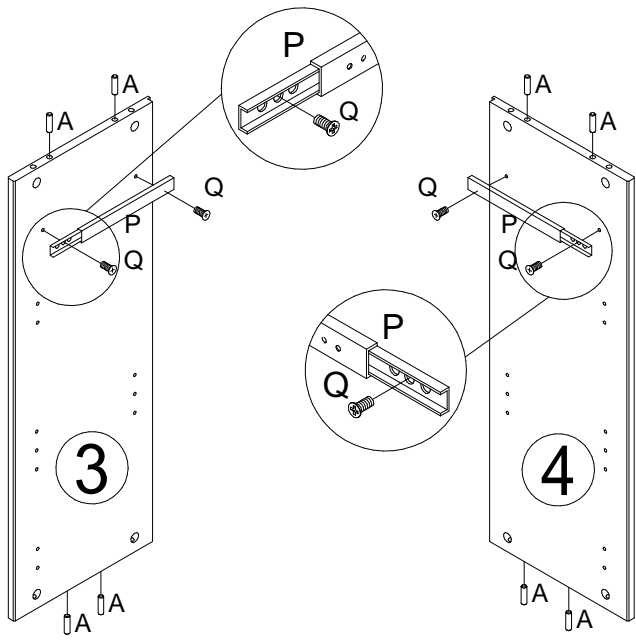

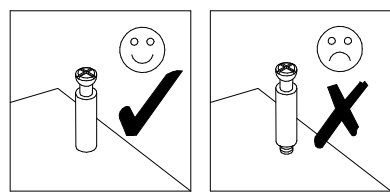
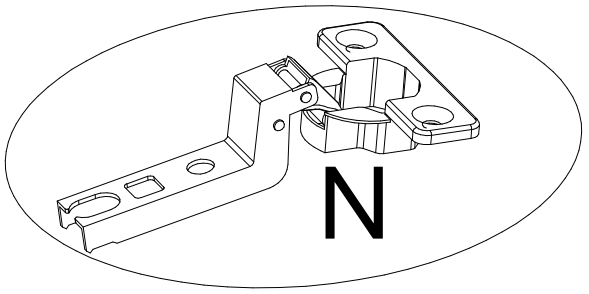
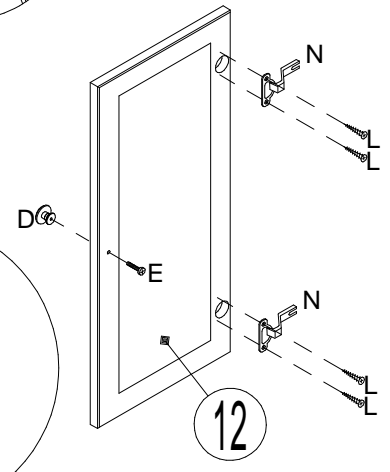
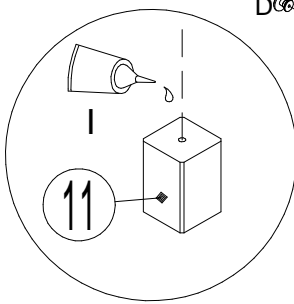
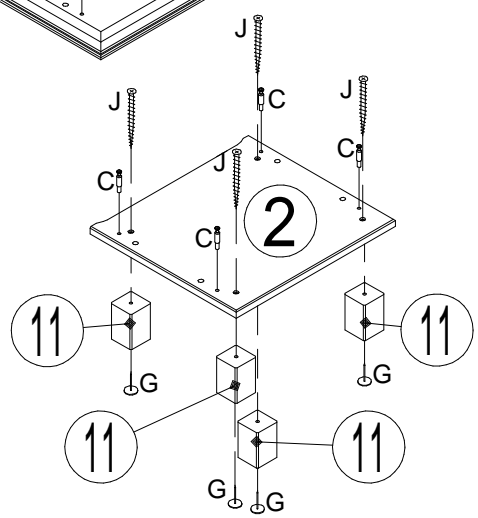
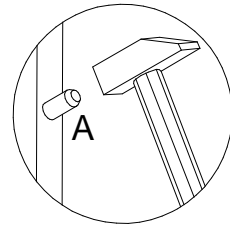
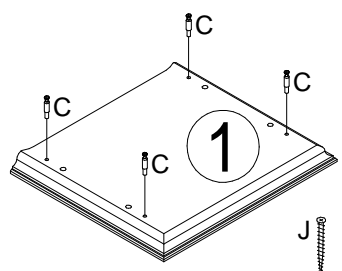
- | | | |
|--|--|--------------|
| P | | x2 |
| A | | 8x30
x8 |
| Q | | 5.8x11
x4 |
| C | | 7x24
x8 |
| D | | x1 |
| J | | 4.0x40
x4 |
| E | | M4x22
x1 |
| N | | x2 |
| G | | x4 |
| I | | x1 |
| D Leim CZ Lepidlo
GB Glue SK Glej
FR Colle HU Enyv
IT Colla RO Adeziv
NL Lijm RU Клей
PL Klej TR Tutkal | | |
| L | | 3.5x15
x4 |

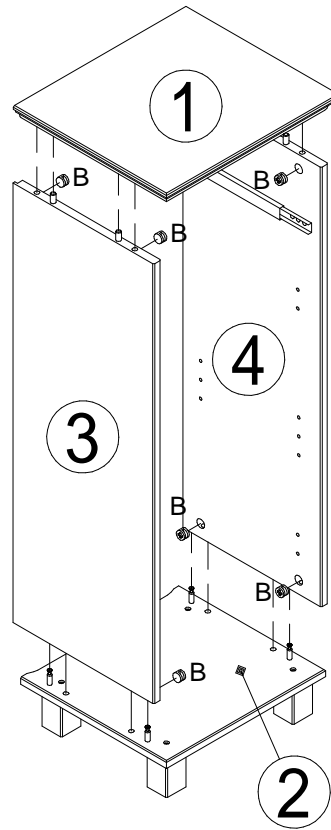

2



B		15x9.5
		x8

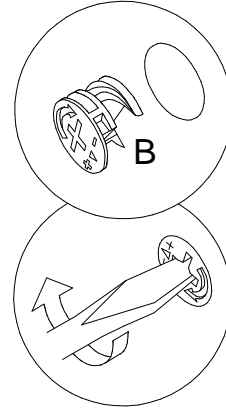

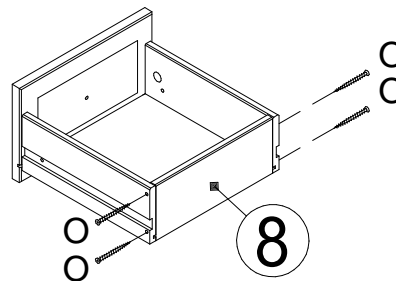
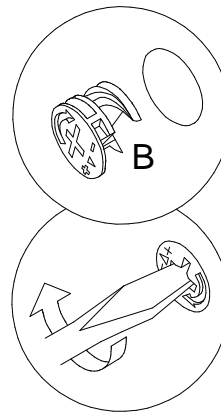
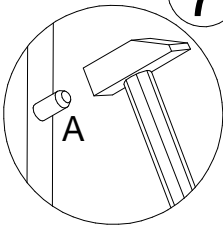
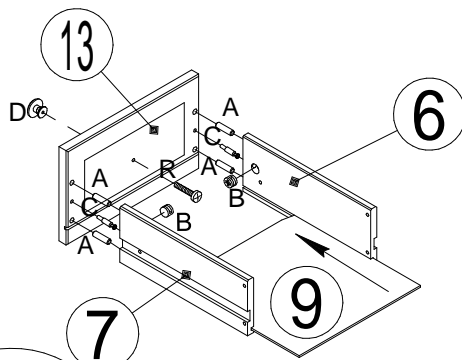

3

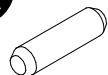

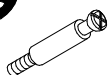

A		8x30
		x4

C		7x24
		x2

B		15x9.5
		x2

D		x1
----------	---	----

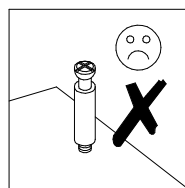
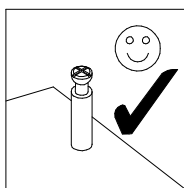

R		M4x10
		x3

O		3.5x35
		x4

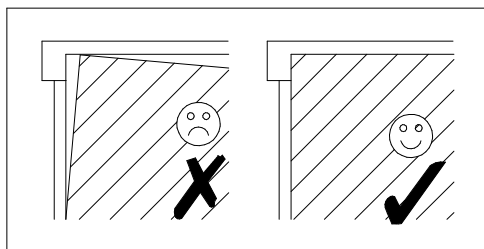
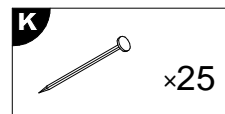
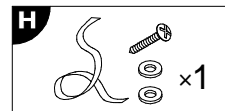
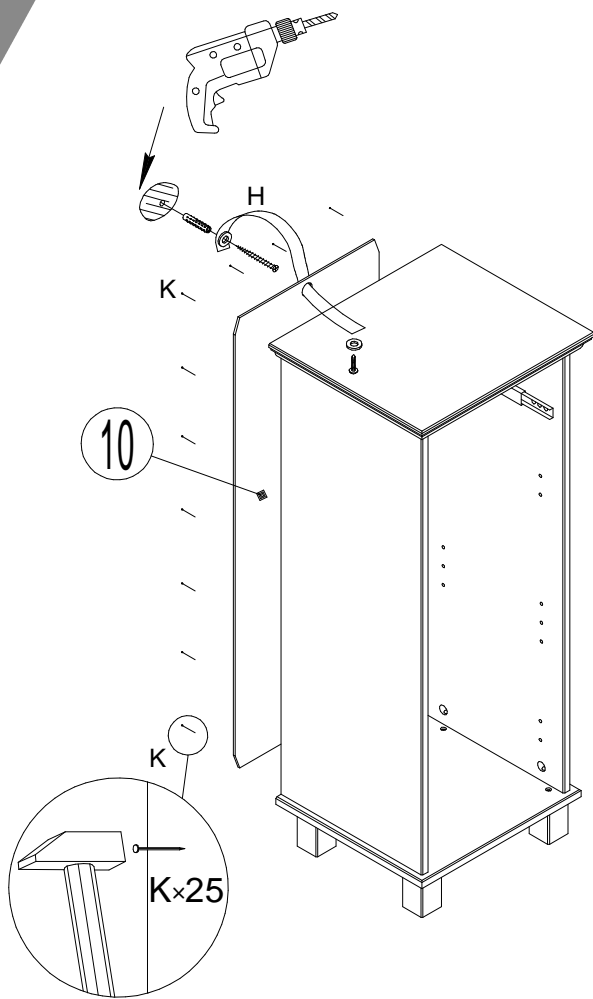

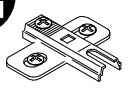

! Achtung • Attention • Attenzione Opgelet • Uwaga • Pozor • Figyelem Atenție • Dikkat • Внимание !	
(D)	Wandbefestigung dient als Kippschutz – unbedingt anbringen! Bei einigen Wandtypen kann ein Spezialdübel erforderlich sein!
(GB)	The wall fastening serves to prevent tipping – be absolutely sure to mount it! For certain wall types, a special wall plug may be necessary!
(FR)	La fixation murale sert de protection contre le basculement – à installer impérativement ! Pour certains types de murs il faut des chevilles spéciales !
(IT)	Il fissaggio alla parete serve da protezione anti-ribaltamento – attaccarla assolutamente! Per alcune strutture di parete può essere necessario un tassello speciale!
(NL)	Bevestiging aan de muur dient als kantelbescherming – zeker en vast bevestigen! Bij enkele muurtypes is een speciale plug mis-schien vereist!
(PL)	Mocowanie do ściany jest jednocześnie zabezpieczeniem przed przewróceniem – koniecznie zamontować! Do niektórych rodzajów ścian koniecznie zastosować specjalne kołki mocujące.
(CZ)	Montáž na stěnu slouží jako ochrana proti převrnutí – bezpodmínečně umístěte! U některých typů stěn může být zapotřebí speciální hmoždinka!
(SK)	Upevnenie na stenu slúži ako ochrana proti prevráteniu – bezpodmienečne použite! Pre niektoré druhy stien môže byť potrebná špeciálna hmoždinka!
(HU)	A termék a falhoz kel rögzítési, különben az felborulhat! Egyes fal típusoknál speciális tiplit kell használni!
(RO)	Sistemul de fixare la perete servește ca protecție la răsturnare – de montat obligatoriu! Pentru unele tipuri de pereți este posibil să fie necesar un diblu special!
(TR)	Duvardaki sabitleme, devrilmeye karşı bir emniyet tedbiridir ve mutlaka monte edilmelidir! Bazı duvar tiplerinde bunun için özel bir dübel gerekli olabilir!
(RU)	Обязательно установите крепление на стене во избежание опрокидывания! Для некоторых типов стен может потребоваться специальный дюбель!

- F**  x4
- M**  x2
- R**  M4x10 x2

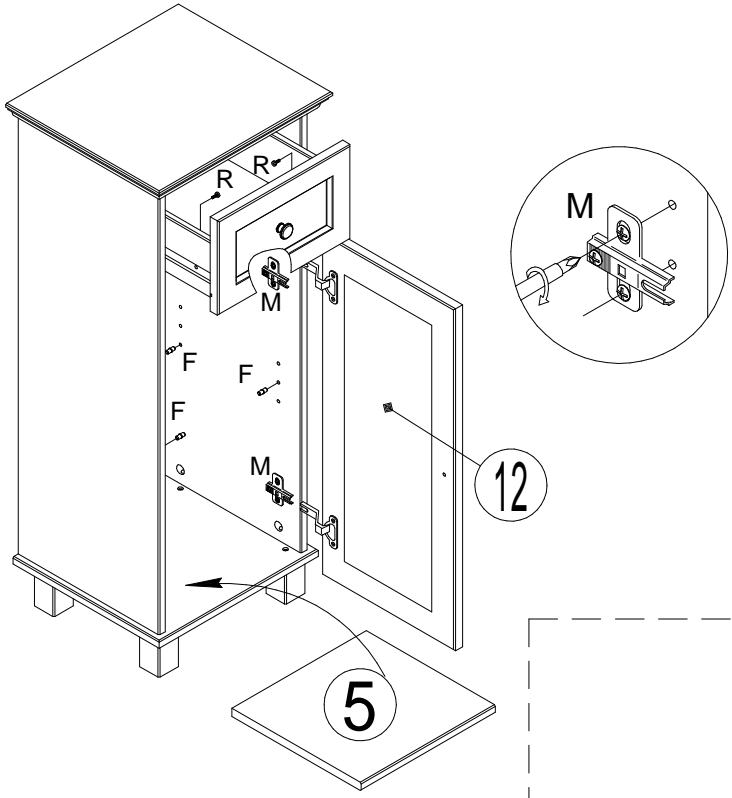

VARIANT 1

VARIANT 2

