

living  
**b.p.c.**  
 bonprix collection

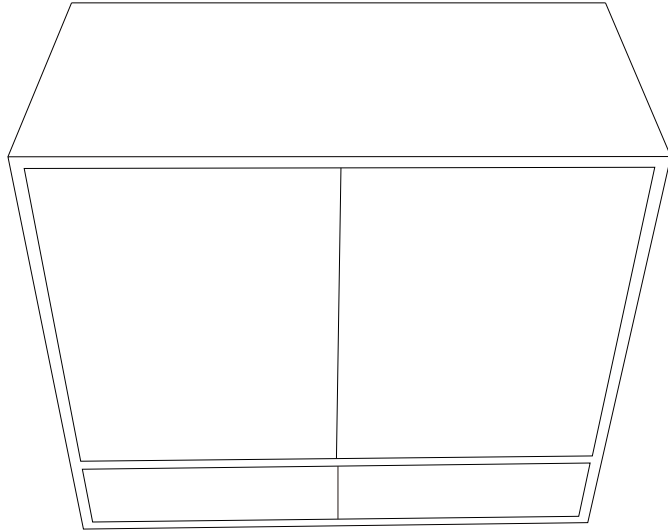

910273

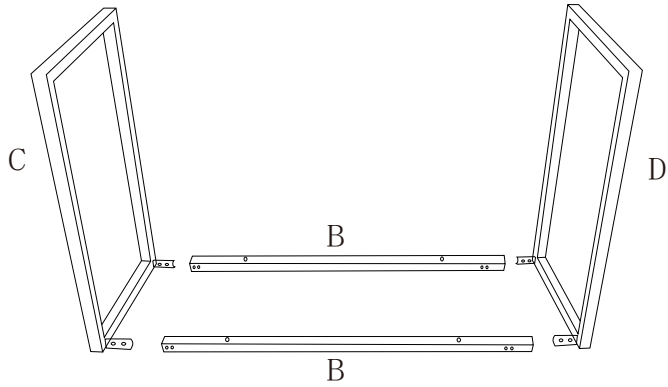
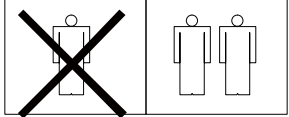

  
**FSC**  
 www.fsc.org  
**100%**  
 Wood from well-  
 managed forests  
**FSC® C153871**

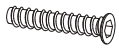

C	X	1
D	X	1
A	X	4
B	X	1

<p>E</p>  <p>6X10mm 8X</p>	<p>F</p>  <p>6X30mm 6X</p>	<p>G</p>  <p>1X</p>
--	---	--

1

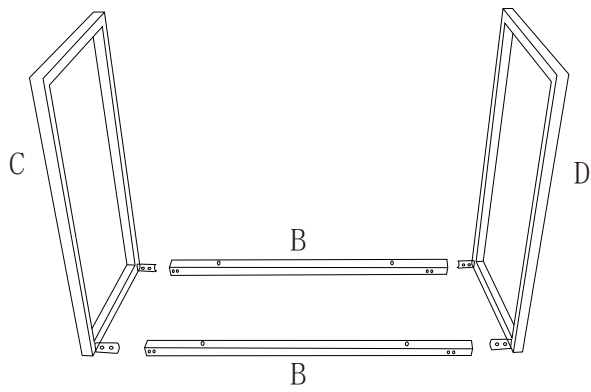

2

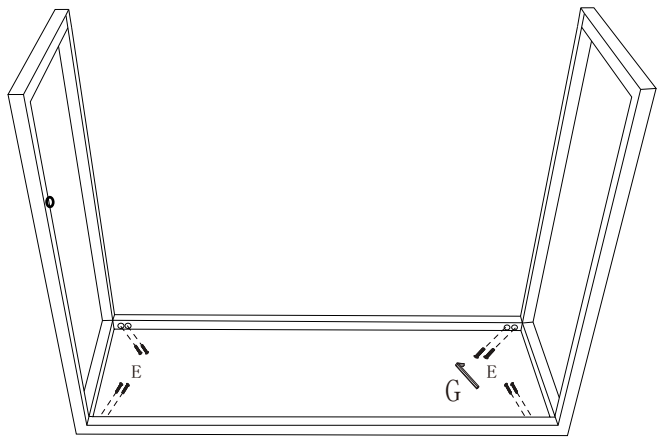

3

